



空氣調理組合-調壓過濾器 系列

訂購稱呼說明與作動規格表

CHELIC



記號:

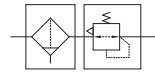

規格表

項目	機種	UFR-400
使用流體		空氣
連接口徑	Rc	1/4、3/8、1/2
過濾精度	μm	5μm
使用壓力範圍	kgf/cm ² (kpa)	0.5~8.5 (50~850)
最大使用壓力	kgf/cm ² (kpa)	10 (1000)
使用溫度	°C	5~60
過濾杯容量	cc	80
重量	kg	0.591
材質	本體	鋁合金壓鑄品
	杯子	耐拉張力之工程塑膠

UC
三點組合

UFC
二點組合

UF
過濾器

UFR
調壓過濾器

UR
調壓器

UL
給油器

UHS
殘壓排放閥

UV
緩和啟動閥

訂購稱呼代號

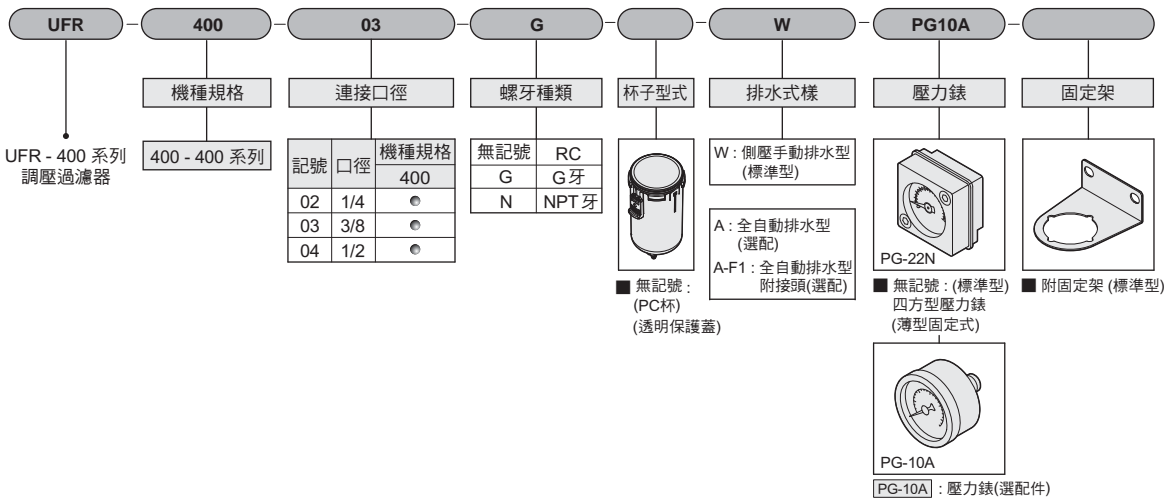



UFR 400 系列-調壓過濾器

流量特性曲線圖

氣立可空氣壓設備

流量特性曲線圖

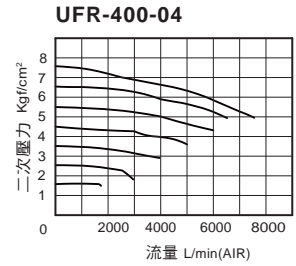
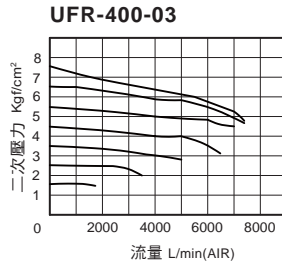
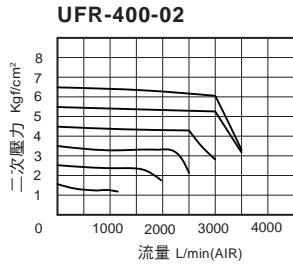

壓力特性曲線圖

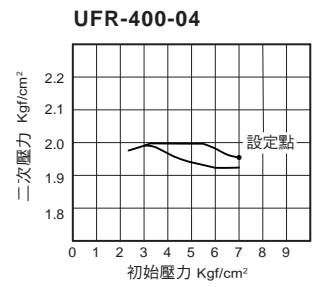
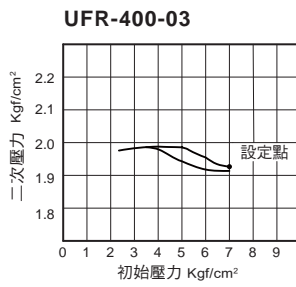
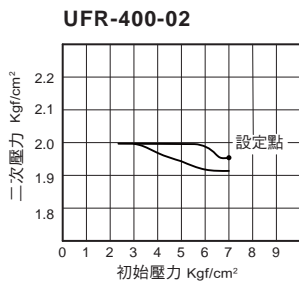

UFR - 400 - [] - W

標準型 / 側壓排水型

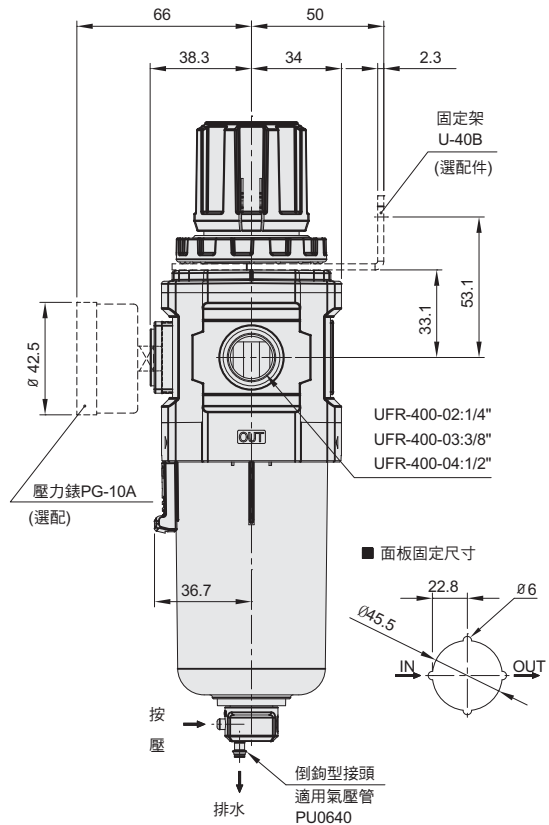
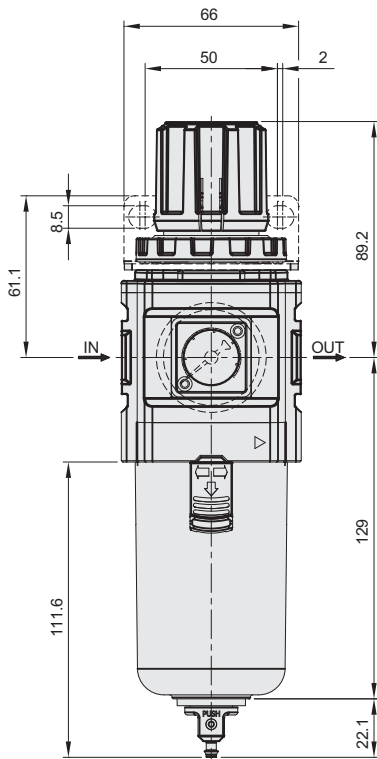

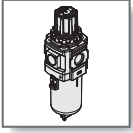

空氣調理組合-調壓過濾器 系列

外觀圖形尺寸

CHELIC

► UFC-400--A
自動排水型

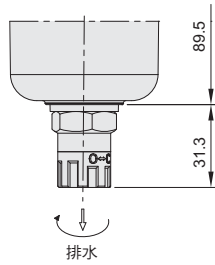

► UFR-400--A-F1
自動排水型 (附接頭)

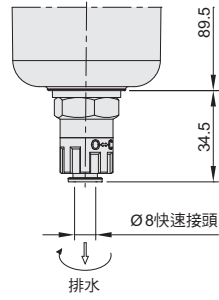

MEMO

氣立可空氣壓設備

A large grid of graph paper for taking notes, consisting of 20 columns and 30 rows of small squares.