

控制類組件 — PMB 底座型氣動閥 系列

PMB3000、PMB5000、PMB7000、PMB9000 氣動閥

CHELIC PNEUMATIC

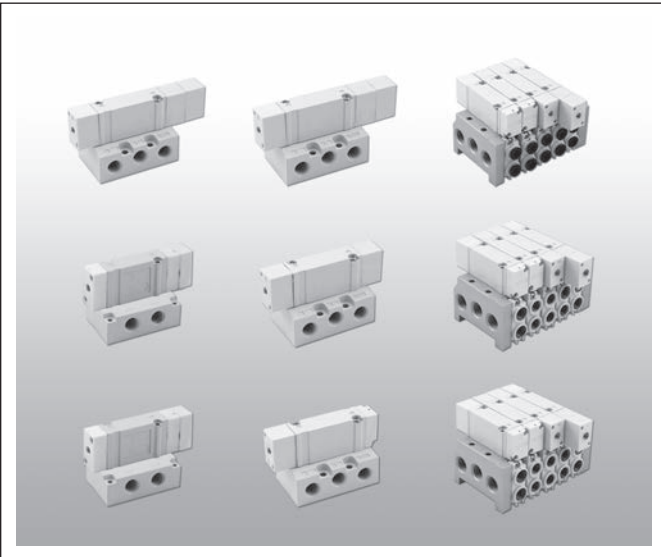

控制閥提供 CAD
外觀圖形尺寸。

小型，大流量之機能！
高速，反應快10ms以下
附指示燈+電壓保護迴路
出氣口可變更，可直接配管

PM
氣動閥

PMB
底座型
氣動閥

PMU
三口二位置
氣動閥

PMUB
三口二位置
底座型氣動閥

PV
氣動閥

PN
氣動閥
NAMUR

<p>PMB 單氣控氣動閥 〔五口二位置〕</p>	PMB - 3000 系列 -- M5 -----	P.2-3.27
	PMB - 5000 系列 -- Rc1/8", Ø4, Ø6, Ø8 -----	P.2-3.29
	PMB - 7000 系列 -- Rc1/8", 1/4", Ø6, Ø8, Ø10 -----	P.2-3.32
	PMB - 9000 系列 -- Rc3/8" -----	P.2-3.35

<p>PMB 雙氣控氣動閥 〔五口二位置〕</p>	PMB - 3000 系列 -- M5 -----	P.2-3.27
	PMB - 5000 系列 -- Rc1/8", Ø4, Ø6, Ø8 -----	P.2-3.29
	PMB - 7000 系列 -- Rc1/8", 1/4", Ø6, Ø8, Ø10 -----	P.2-3.32
	PMB - 9000 系列 -- Rc3/8" -----	P.2-3.35

<p>PMB 雙氣控氣動閥 〔五口三位置〕</p>	PMB - 3000 系列 -- M5 -----	P.2-3.28
	PMB - 5000 系列 -- Rc1/8", Ø4, Ø6, Ø8 -----	P.2-3.30
	PMB - 7000 系列 -- Rc1/8", 1/4", Ø6, Ø8, Ø10 -----	P.2-3.33
	PMB - 9000 系列 -- Rc3/8" -----	P.2.3.36

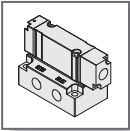

PMB 系列 – 3000、5000、7000、9000 底座型氣動閥

作動規格表與訂購稱呼說明

CHELIC PNEUMATIC

內部結構圖

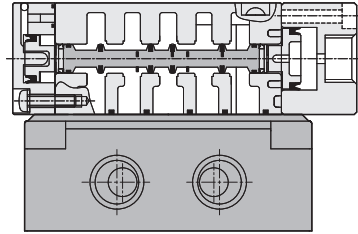
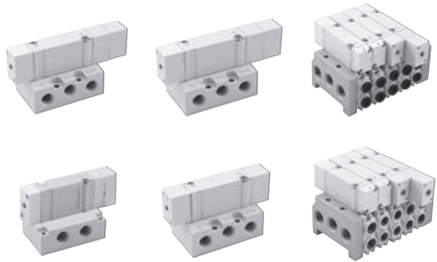

PM
氣動閥

PMB
底座型
氣動閥

PMU
三口二位置
氣動閥

PMUB
三口二位置
底座型氣動閥

PV
氣動閥

PN
氣動閥
NAMUR

規格表

項目	機種	PMB3000	PMB5000	PMB7000	PMB9000		
使用流體		空氣					
使用壓力範圍	kgf/cm ² (Kpa)	1.5~7(150~700)					
使用溫度範圍	°C	0~60					
切控方法		空氣導引					
氣口數及位置數		5口 2位置	5口 3位置	5口 2位置	5口 3位置	5口 2位置	5口 3位置
閥仕様		常閉型					
有效斷面積	mm ² (CV)	3.6(0.2)	10.8(0.6)	18.2(1.0)	36(2.0)		
連接口徑		M5, Rc 1/8, Ø4, Ø6, Ø8			Rc1/8, Rc 1/4, Ø6, Ø8, Ø10	Rc 3/8	
潤滑		自由供給方式					

訂購稱呼代號

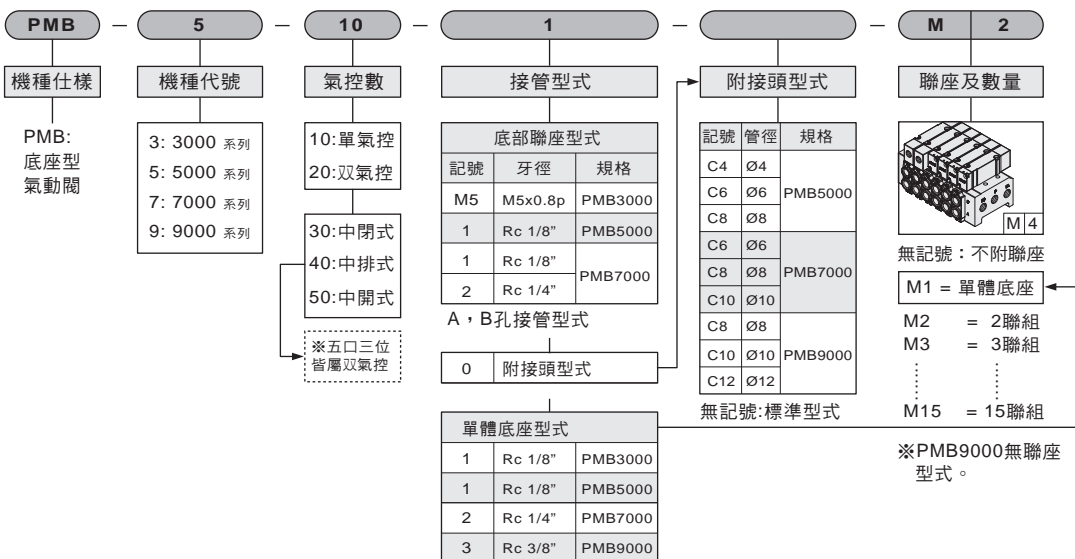

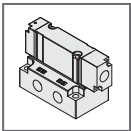

PMB 系列 – 3000、5000、7000、9000 底座型氣動閥

零件名稱及相關材料表

氣立可空氣壓設備

● 單氣控 五口二位置

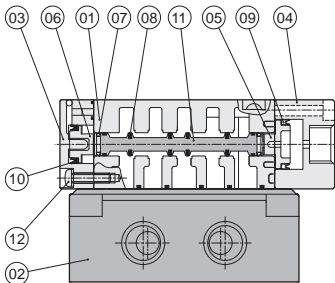

● 雙氣控 五口二位置

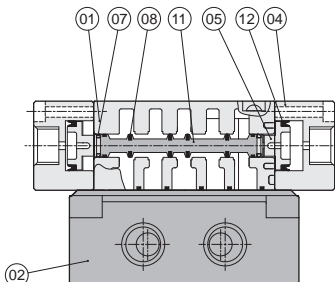
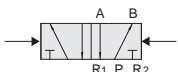

● 雙氣控 五口三位置

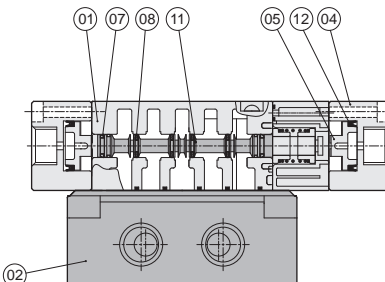
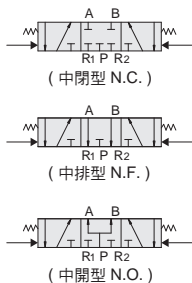

◎ 零件名稱及材料表

編號	項目	材質	編號	項目	材質
01	本體	鋁合金	7	滑軸迫緊	耐油膠
02	單體聯座	鋁合金	8	滑軸迫緊	耐油膠
03	後蓋	飽合聚酯	9	中座活塞迫緊	耐油膠
04	氣控中座	鋁合金	10	後蓋活塞迫緊	耐油膠
05	中座活塞	塑鋼	11	滑軸	鋁合金
06	後蓋活塞	塑鋼	12	後蓋固定螺絲	合金鋼

☞ 註：本體外觀採用烤漆處理。

◎ 迫緊及O型零件表

項目		中座活塞迫緊	後蓋活塞迫緊
機種	數量	1	1
	PMB 5000	MYA-10	MYA-7
	PMB 7000	MYA-11	MYA-7

☞ 註：活塞迫緊及輪用迫緊，全採用進口品（三菱，阪上及相等級規格。）

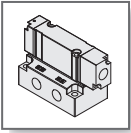

PMB 系列 底座型氣動閥 – PMB 3000

外觀圖形尺寸 / 標準型

CHELIC PNEUMATIC

◉ PMB 3101

底部排氣單體底座型
單氣控 五口二位置

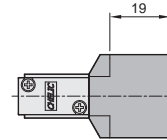
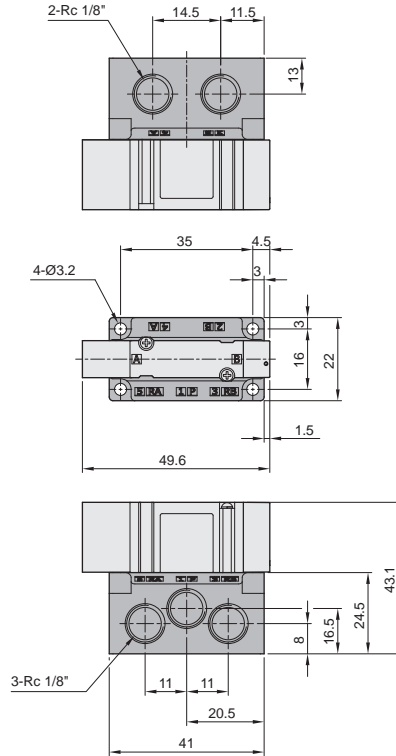
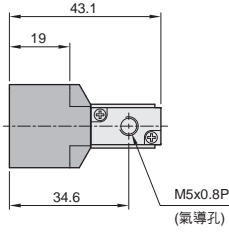
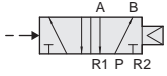

PM
氣動閥

PMB
底座型
氣動閥

PMU
三口二位置
氣動閥

PMUB
三口二位置
底座型氣動閥

PV
氣動閥

PN
氣動閥
NAMUR

◉ PMB 3201

底部排氣單體底座型
雙氣控 五口二位置

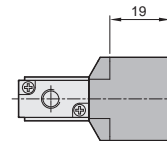
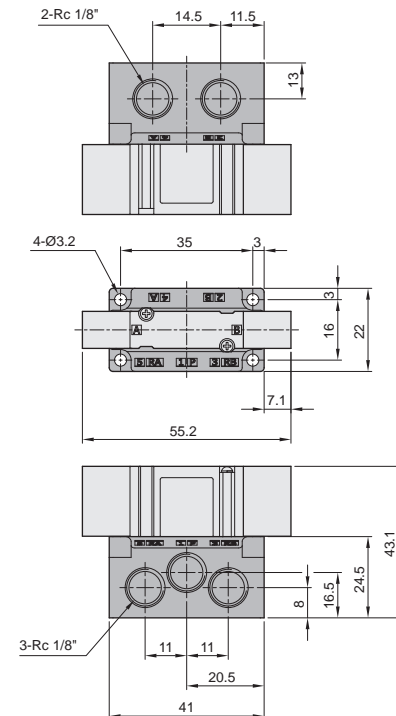
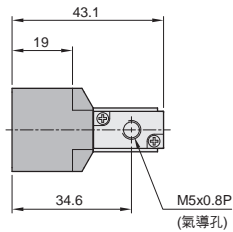

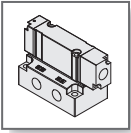

PMB 系列 底座型氣動閥 – PMB 3000

外觀圖形尺寸 / 標準型

氣立可空氣壓設備

● PMB 3(3)01

PMB 3(4)01

PMB 3(5)01

底部排氣單體底座型

雙氣控 五口三位置

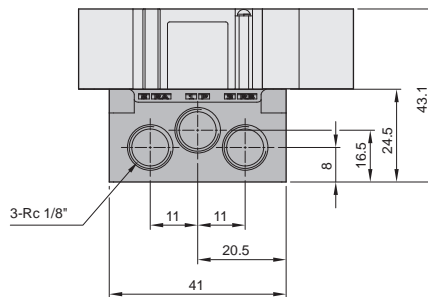
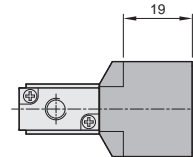
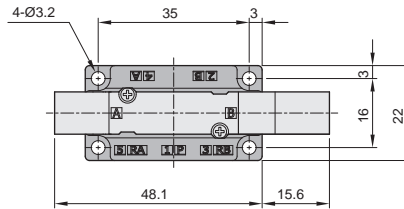
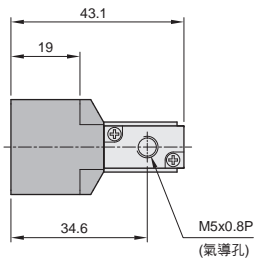
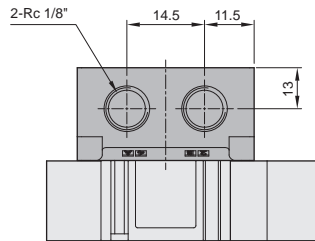
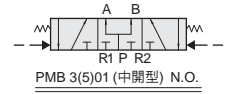
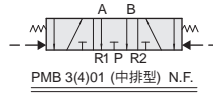
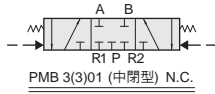

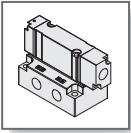

PMB 系列 底座型氣動閥 – PMB 5000

外觀圖形尺寸 / 標準型

CHELIC PNEUMATIC

● PMB 5101

底部排氣單體底座型
單氣控 五口二位置

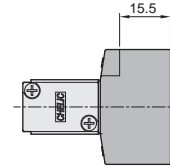
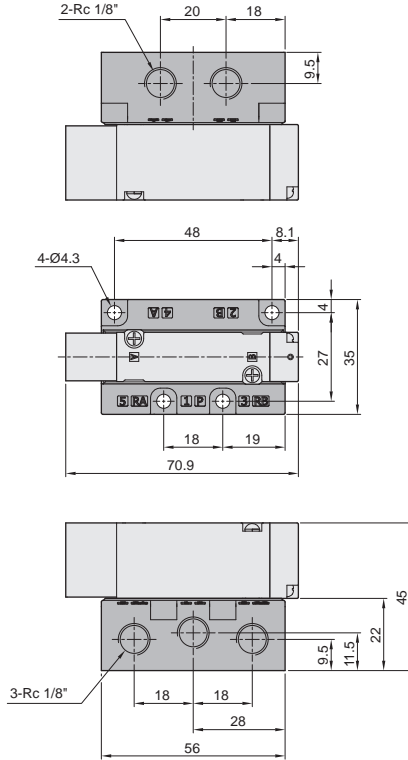
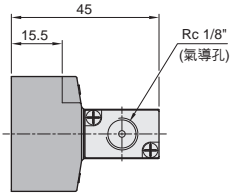
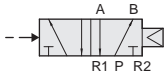

PM
氣動閥

PMB
底座型
氣動閥

PMU
三口二位置
氣動閥

PMUB
三口二位置
底座型氣動閥

PV
氣動閥

PN
氣動閥
NAMUR

● PMB 5201

底部排氣單體底座型
雙氣控 五口二位置

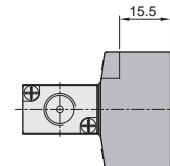
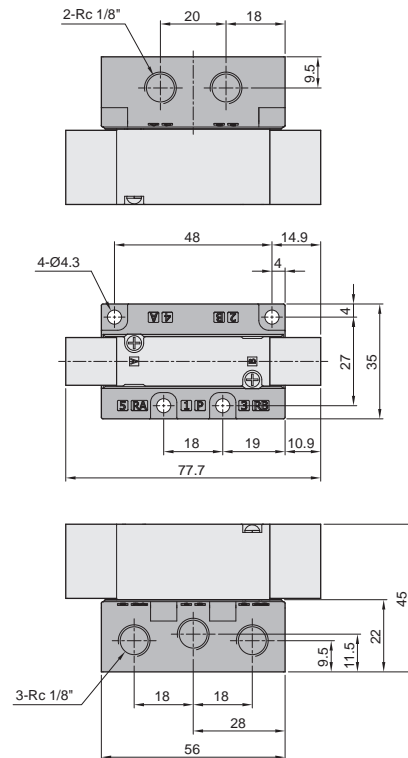
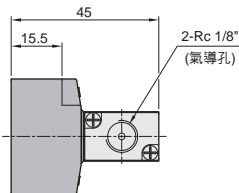

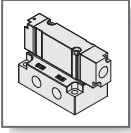

PMB 系列 底座型氣動閥 – PMB 5000

外觀圖形尺寸 / 標準型

氣立可空氣壓設備

● PMB 5(3)01

PMB 5(4)01

PMB 5(5)01

底部排氣單體底座型
雙氣控 五口三位置

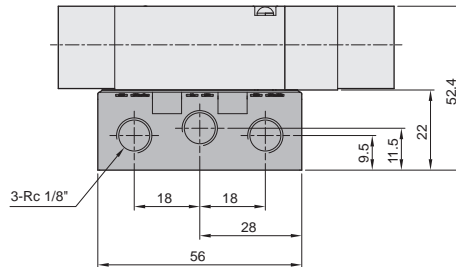
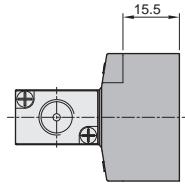
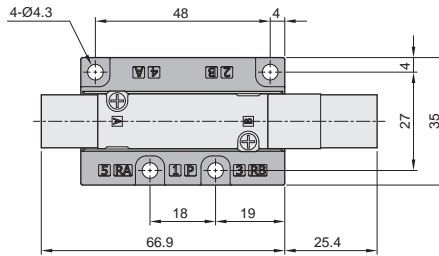
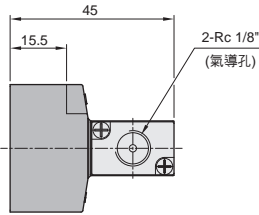
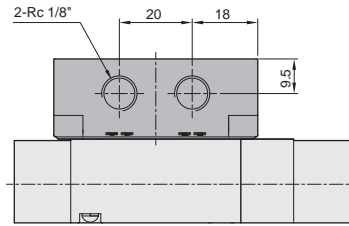
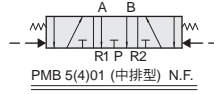
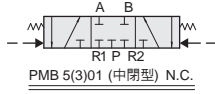

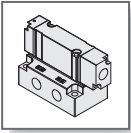

PMB 系列 底座型氣動閥 – PMB 5000

外觀圖形尺寸 / 聯座型式

CHELIC PNEUMATIC

● PMB - 5000 系列 - 標準型 聯座尺寸

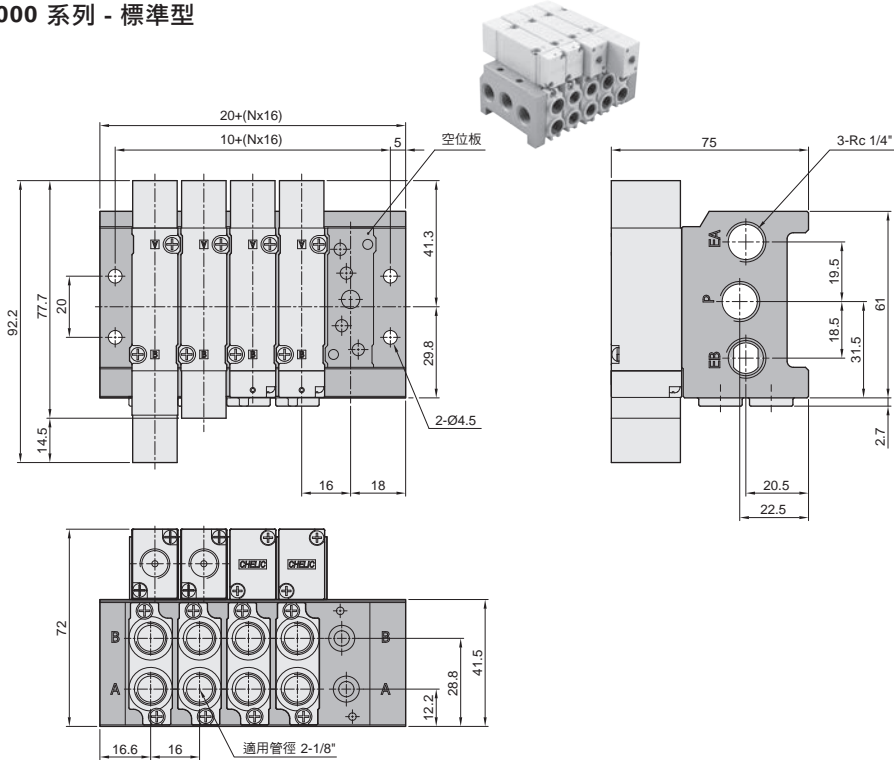

PM
氣動閥

PMB
底座型
氣動閥

PMU
三口二位置
氣動閥

PMUB
三口二位置
底座型氣動閥

PV
氣動閥

PN
氣動閥
NAMUR

● PMB - 5000 系列 - 附接頭型式 聯座尺寸

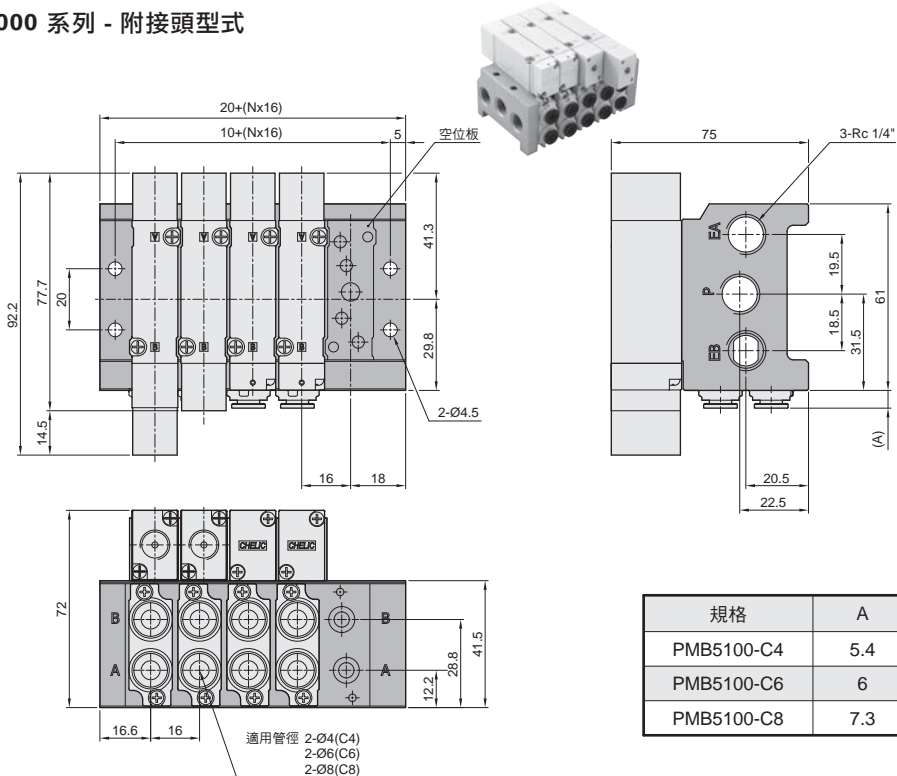

規格	A
PMB5100-C4	5.4
PMB5100-C6	6
PMB5100-C8	7.3

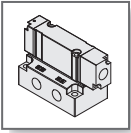

PMB 系列 底座型氣動閥 – PMB 7000

外觀圖形尺寸 / 標準型

氣立可空氣壓設備

● PMB 7102

底部排氣單體底座型
單氣控 五口二位置

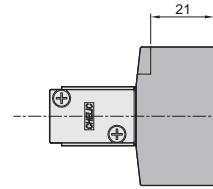
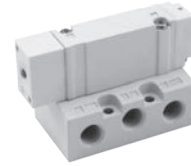
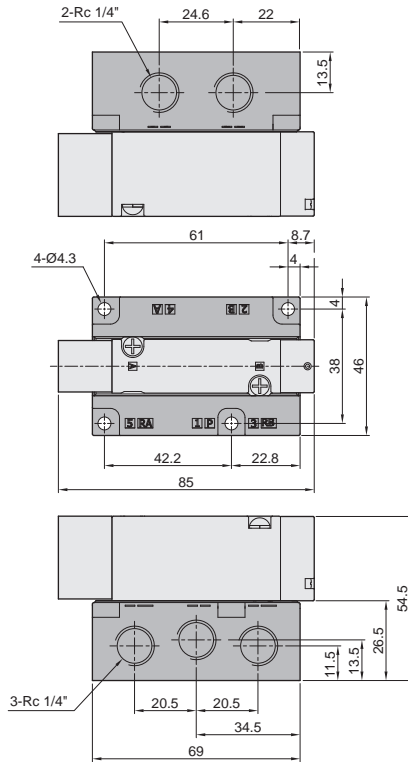
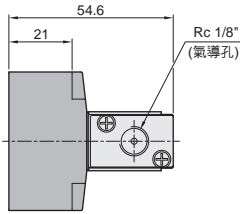
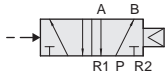

● PMB 7202

底部排氣單體底座型
雙氣控 五口二位置

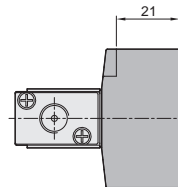
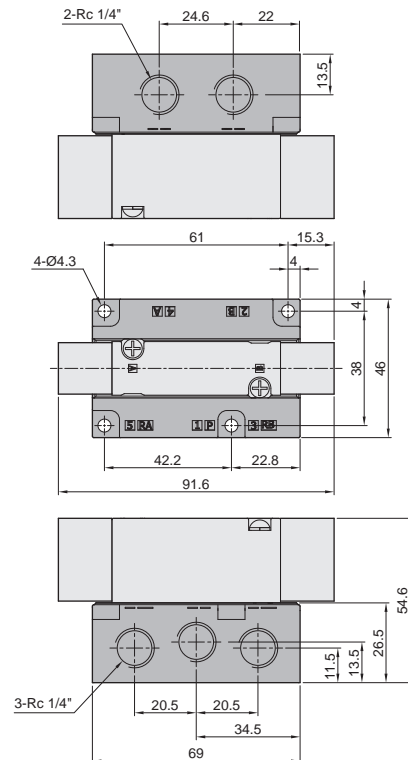
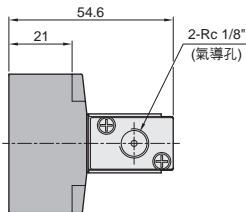

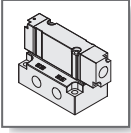

PMB 系列 底座型氣動閥 – PMB 7000

外觀圖形尺寸 / 標準型

CHELIC PNEUMATIC

- PMB 7(3)02
- PMB 7(4)02
- PMB 7(5)02

底部排氣單體底座型
雙氣控 五口三位置

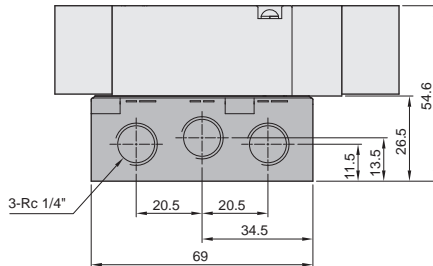
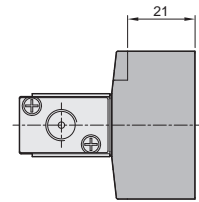
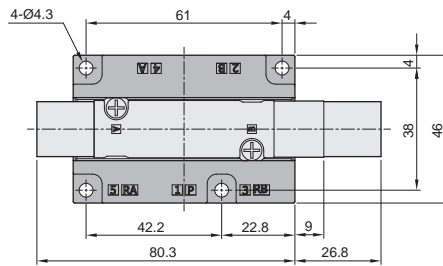
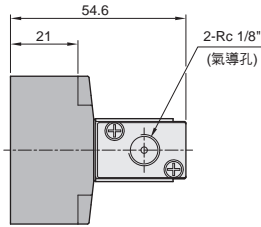
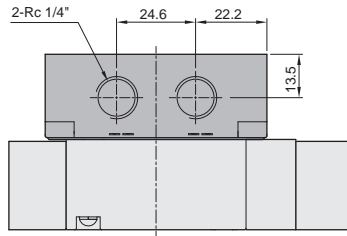
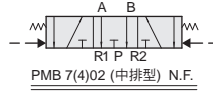
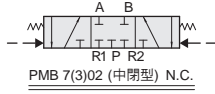

PM
氣動閥

PMB
底座型
氣動閥

PMU
三口二位置
氣動閥

PMUB
三口二位置
底座型氣動閥

PV
氣動閥

PN
氣動閥
NAMUR

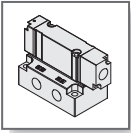

PMB 系列 底座型氣動閥 – PMB 7000

外觀圖形尺寸 / 聯座型式

氣立可空氣壓設備

● PMB - 7000 系列 - 標準型 聯座尺寸

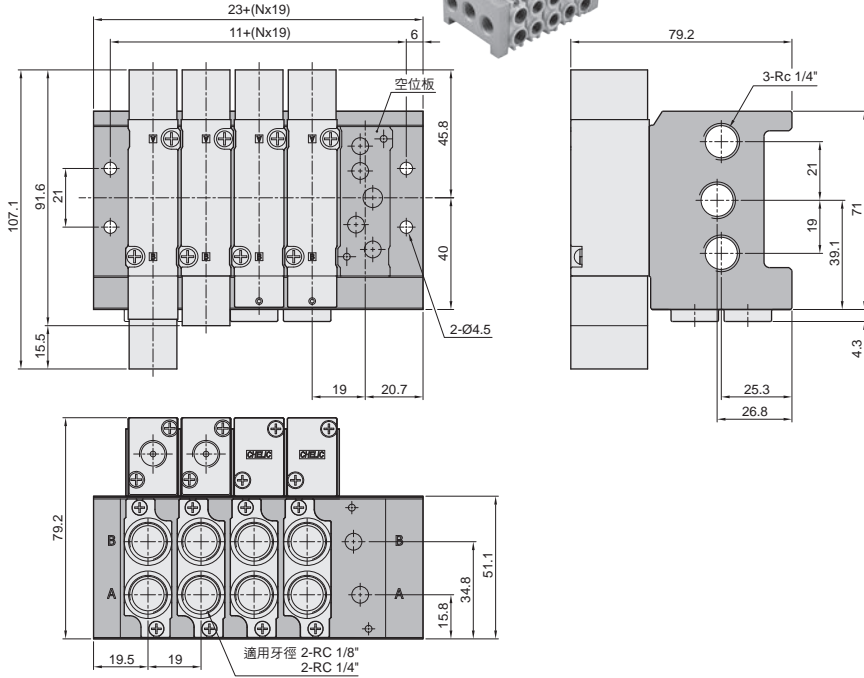

● PMB - 7000 系列 - 附接頭型式 聯座尺寸

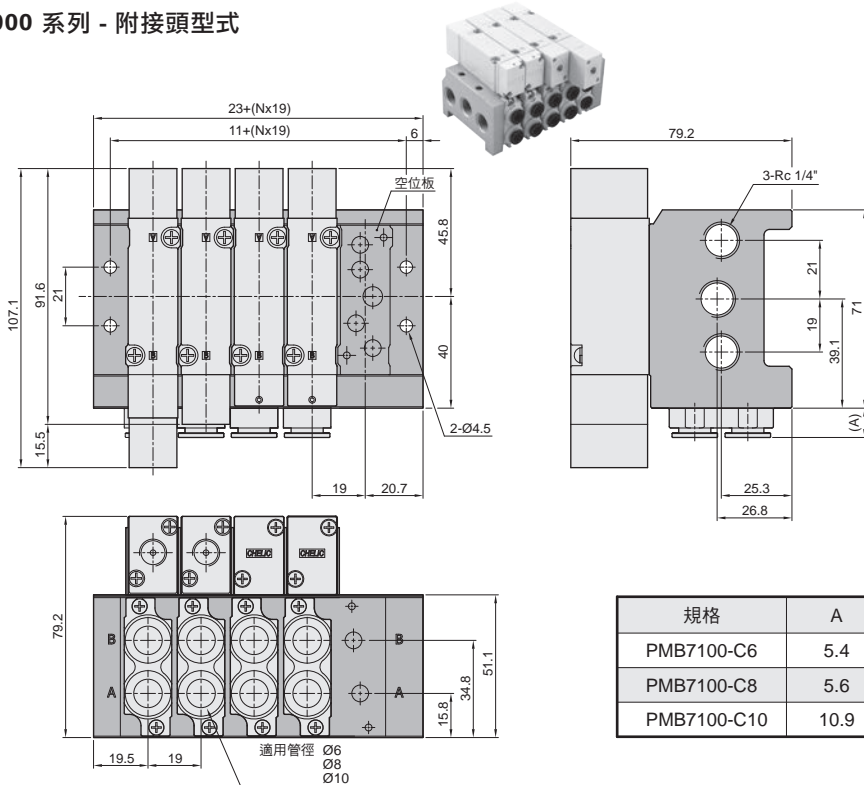

規格	A
PMB7100-C6	5.4
PMB7100-C8	5.6
PMB7100-C10	10.9

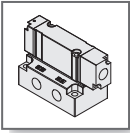

PMB 系列 底座型氣動閥 – PMB 9000

外觀圖形尺寸 / 標準型

CHELIC PNEUMATIC

► PMB 9103

底部排氣單體底座型
單氣控 五口二位置

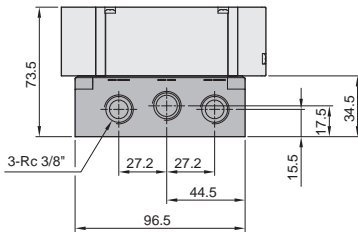
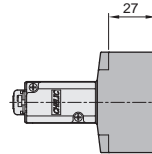
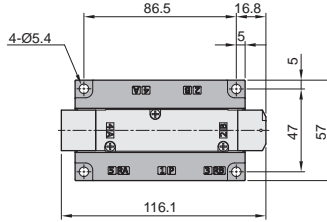
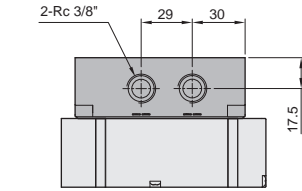
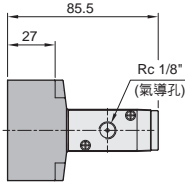
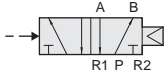

► PMB 9203

底部排氣單體底座型
雙氣控 五口二位置

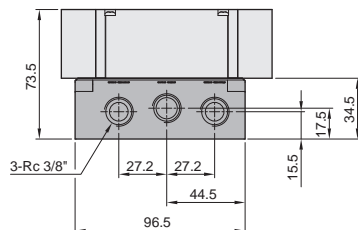
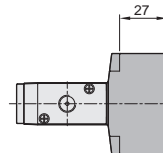
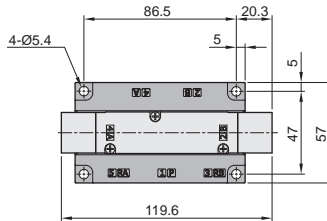
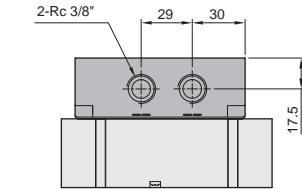
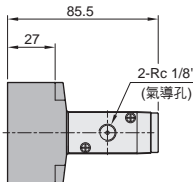

PM
氣動閥

PMB
底座型
氣動閥

PMU
三口二位置
氣動閥

PMUB
三口二位置
底座型氣動閥

PV
氣動閥

PN
氣動閥
NAMUR

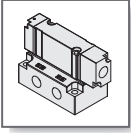

PMB 系列 底座型氣動閥 – PMB 9000

外觀圖形尺寸 / 標準型

氣立可空氣壓設備

- PMB 9(3)03
- PMB 9(4)03
- PMB 9(5)03

底部排氣單體底座型
雙氣控 五口三位置

